

#44 2-Sided nonlit

Freestanding / Hanging / Wallmount

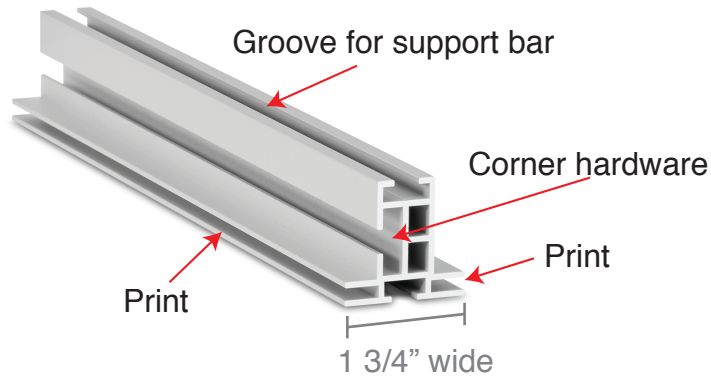

Our #44 nonlit is a great way to display directional and informational signage.

Specifications: #44 2-Sided Nonlit

Application: Freestanding / Hanging / Wallmount

Depth: 1.75"

Length: 18.5' UNCUT. With butt join, unlimited length.

Weight: .75 lb./ft.

Option: Works with acoustic panel









Colors: Silver, Black, White. Custom colors and finishes available.

Silicon Strip size: 3mm thick x 12-14mm wide

This aluminum profile is designed for freestanding and / or suspended display of SEG graphics. This profile has a double channel, for placing two textile prints in the frame front and back. With the extension hardware and support bars, every size is possible

- Feet available for free-standing
- Corner and support bars
- Stabilizers for optimum reinforcement
- Ceiling hanger for hanging
- This frame knocks down for economical shipping.
- Assembly is easy.

ALSO AVAILABLE: #45, IDENTICAL TO #44, EXCEPT WITH NO OUTSIDE GROOVE, SMOOTH SURFACE.

ACCESSORIES					
	Corner hardware FK-0209	6 options of flat feet	#20 with FK-0222 45° connector	Acoustic Panel	
					
180° Connectors FK-0509	4 options of flat feet with vertical support	#20 with FK-022 90° connector	Wall Mounts FK-0445	Ceiling Pendant FK-0361	